

This diagram of towel ladder shape is only a reference, all towel ladder installation manuals from our range unless specified are based on the same installation concept.

## Step 1

## Fittings

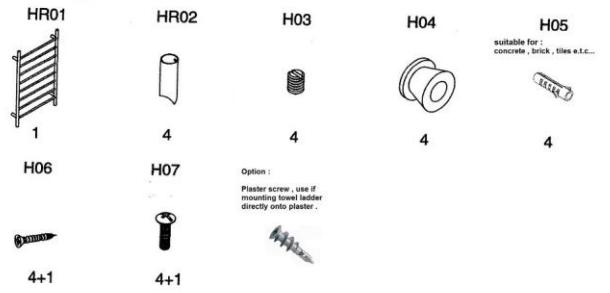

## Tools needed



## Step 2

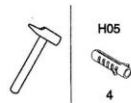
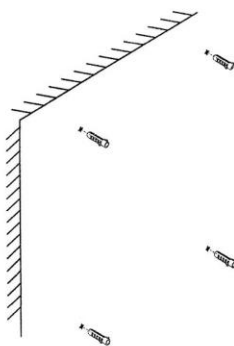
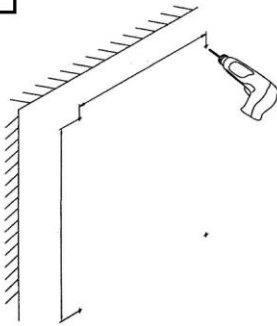

Option :  
Plaster screw , use if  
mounting towel ladder  
directly onto plaster .  

## Step 3

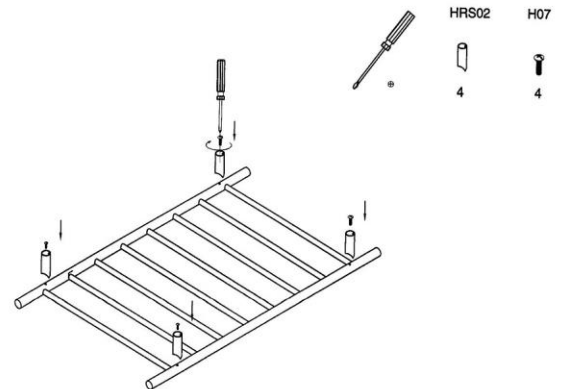
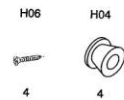
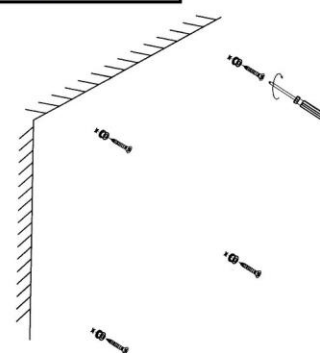

**Step 4**

